

18 格長方形紙條 (活動一、二適用)

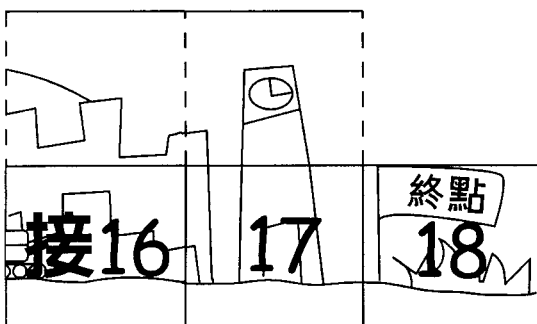

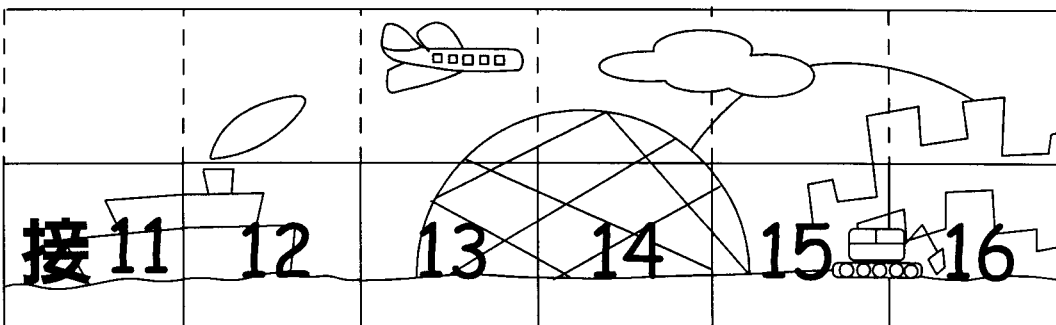

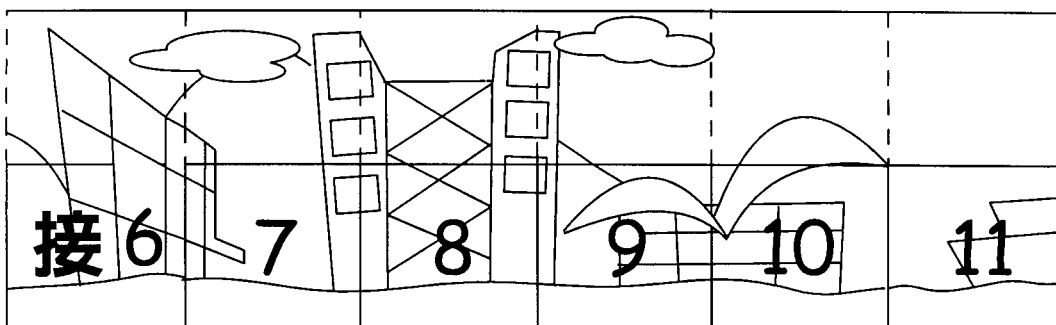
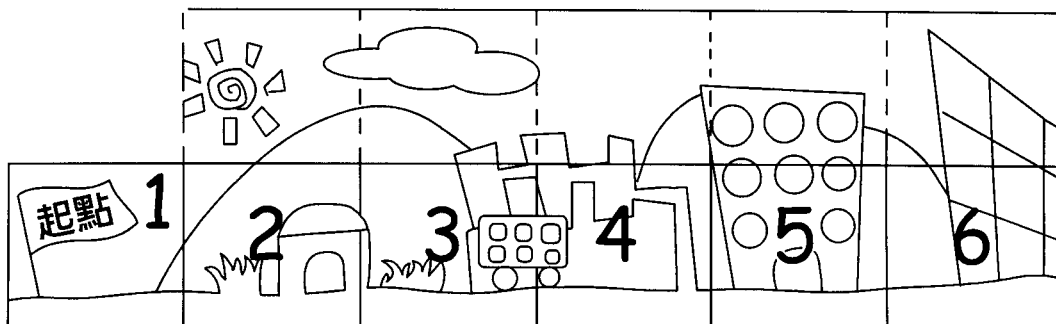
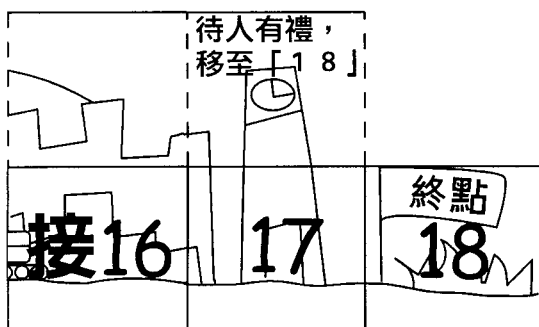
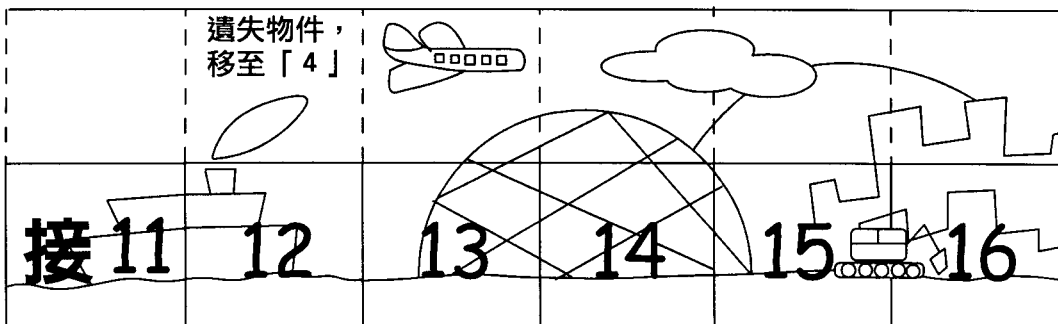
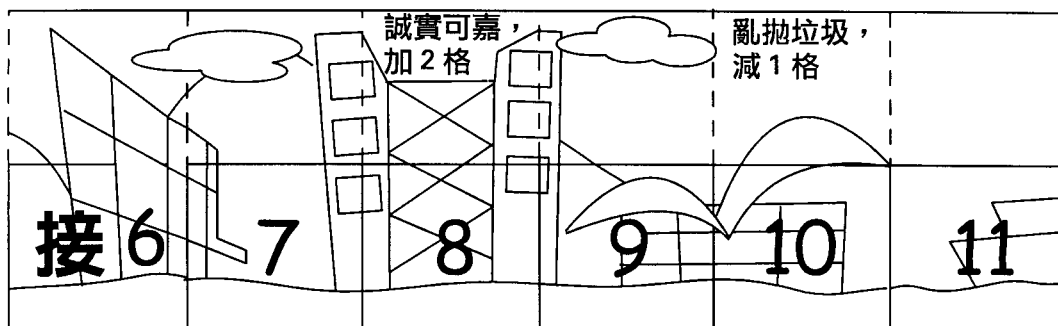
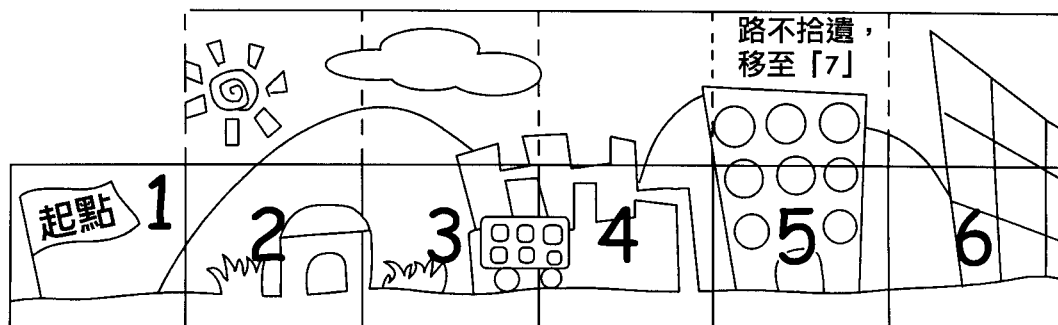

將各段紙條剪下、
接駁。
沿虛線剪開紙條上
半部，用作覆蓋數
字。

18 格長方形紙條 (活動三適用)

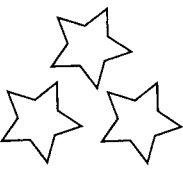
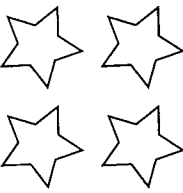
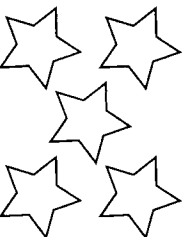
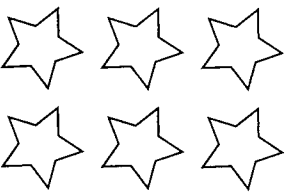
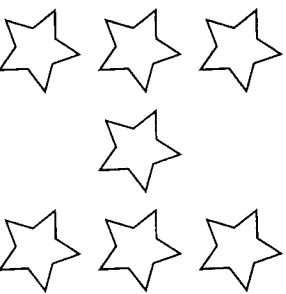

將各段紙條剪下、接駁。
沿虛線剪開紙條上半部，用作覆蓋數字。

數字卡

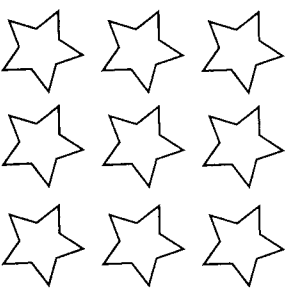
		
1	2	3
		
4	5	6
		
7	8	9